

ATN IR850 Pro

LONG RANGE 850 mW INFRA-RED ILLUMINATOR



USER'S GUIDE (IR850 PRO) REVISION 2 – AUGUST, 2017

u s e r ' s g u i d e

Important Export Restrictions! Commodities, products, technologies and services contained in this manual are subject to one or more of the export control laws and regulations of the US BIS-Department of Commerce, Export Administration Regulations. It is unlawful and strictly prohibited to export, or attempt to export or otherwise transfer or sell any hardware or technical data or furnish any service to any foreign person, whether abroad or in the United States, for which a license or written approval of the U.S. Government is required, without first obtaining the required license or written approval from the Department of the U.S. Government having jurisdiction. Diversion contrary to U.S. law is prohibited.



**AMERICAN
TECHNOLOGIES
NETWORK
CORP.**

INTRODUCTION

Congratulations on choosing the ATN IR850 Pro; an extremely powerful, long range 850 mW infra-red illuminator that is perfect for hunting, law enforcement, search and rescue, and military use.

Before using your IR850 Pro, please read this manual carefully. Also, refer to the troubleshooting tips for any issues/problems.

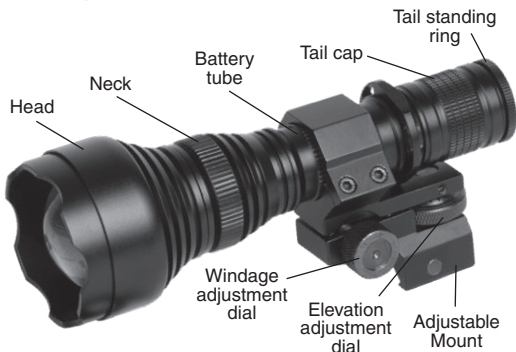

SPECIFICATIONS

LED Module	Using high power emitter with the IR850 Pro driver
Output	Single lithium battery that drives the emitter at 1~1.8 A
Lens	Aspherical glass
Material	Constructed using aircraft grade aluminium
Surface	Type III hard anodized with highly durable finish
Waterproof	IPX8
Battery type	18650R rechargeable; 3,7 V Lithium Ion
Dimensions, mm	160 (length) x 54 (head) x 25 (body) x 27 (tail)
Weight, g	380
Color	Black

** ATN reserves the right to change the above specifications at any time without notice*

FEATURES

- Constructed from aircraft grade aluminium.
- Waterproof to IPX8 standard.
- Two modes of operation.
- Flawless white beam
- Easy rail mounting system
- Accessories: battery charger
- One-year Warranty

BATTERY

NOTE: Please hold the battery tube (not the lens or the neck of the lens) when Tightening/ loosening the tail-cap.

The IR850 Pro comes with a single Lithium Ion rechargeable battery. IR Illuminator uses a single Lithium Ion rechargeable battery, 18650R.

1. Unscrew the Tail cap from the Battery Tube, until it is free.
2. Place Battery within the Battery Tube, observing proper battery polarity.
3. Screw the Tail cap to the right.

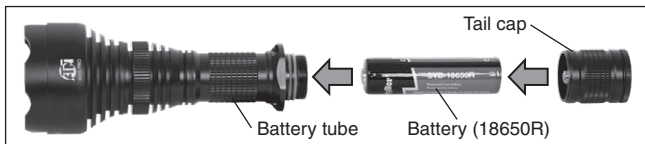

MODES

The ATN IR850 PRO consists of 2 possible modes

- Tactical mode — a high brightness output, not recommended for general use;
 - General mode — allows for use low, medium, and high brightness outputs.
- Insert the provided battery (18650) into the battery tube. Place the Tail cap back over the Battery tube and turn clockwise to secure.

TACTICAL MODE

1. To activate tactical mode, tighten the battery tube by twisting the tube clockwise, until snug tight.
2. Your IR850 PRO will only produce a high brightness output when the on/off button is pressed.

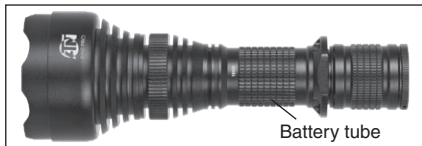

GENERAL MODE

To activate general mode, turn the battery tube counter-clockwise, about $\frac{1}{2}$ turn.

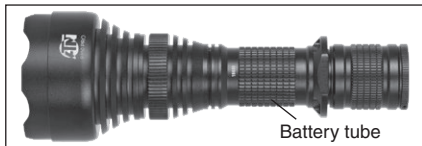

GENERAL MODE VERIFICATION

WARNING: Do not look directly at the IR without proper Personal Protective Equipment (PPE).

1. Open the camera application from your phone or tablet.
2. With the IR850 PRO turned off, place it underneath the phone or tablet with the lens facing the camera.
3. Press and release the on/off button half-way and without clicking the button. You can view the different IR output stages (low, medium, high) from your phone/tablet camera. Refer to the Figure below.

Repeat this step to cycle through the different brightness outputs of the IR850 PRO.

4. Once the preferred output is determined, hold and push the button until a click occurs. Leave the IR on for about 3 seconds. Turn off the unit. The output setting is now saved.
5. If your IR850 PRO does not cycle through different brightness outputs, loosen the battery tube slightly and repeat steps 1 – 5.

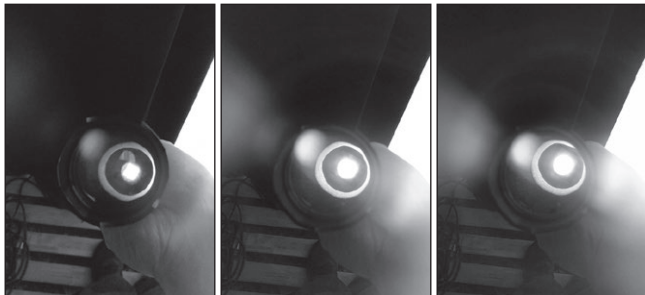

Low output setting

Medium output setting

High output setting

ACTIVATE GENERAL MODE ONLY

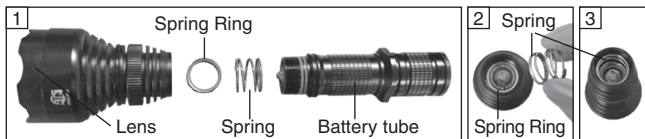

NOTE: To activate general mode only with a tightened battery tube, the spring ring needs to be placed towards the lens.

1. Unscrew the IR850 PRO battery tube from the lens, and take out the spring ring and spring from the assembly.
2. Connect the spring ring and spring as shown.
3. Insert the spring into the lens, with the ring making contact with the lens housing.
4. Assemble the IR850 PRO lens and battery tube back together. Ensure the battery tube is snug tight with the lens housing.
5. Your IR850 PRO should now only be able to operate in General Mode.

FOCUS

Turn the light to maximum output and shine it on a wall 8~10 m away. To focus the beam, hold the lens head in one hand and turn the battery tube with your other hand. Turn clockwise or counter-clockwise till the focus is to your liking.

ADJUSTABLE MOUNT

Attach the IR850 Pro, adjust the mount as follows:

1. Unscrew the four screws [1] securing the top of the bracket [2] and the bottom [3] half of the adjustable mount.
2. Place the top and lower parts of the adjustable mount around the IR850 Pro.
3. Using an Allen wrench, secure the four screws [1]. Do not apply excessive torque.

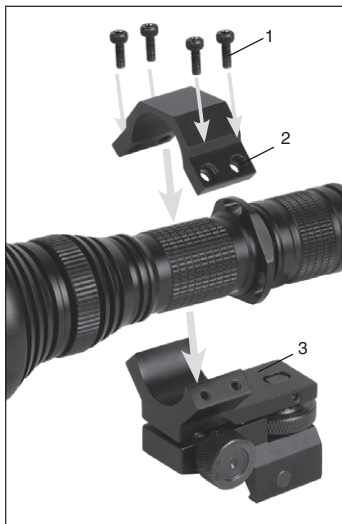

ADJUSTMENT

To adjust the windage and elevation, the two round dials must be turned/adjusted.

The round dial on the left is your elevation adjustment. The flat dial is your windage adjustment.

Adjust each dial until your IR light is centered with your picture.

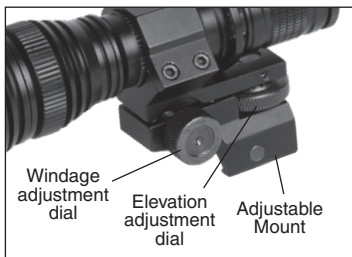

MAINTENANCE

Lubricate the threads and O-Rings to prevent wear and retain water retention. This will help prevent drying.

TROUBLESHOOTING

Dimming Light

1. Battery may be faulty. Try another fully charged battery.
2. Battery may need charging. Charge your battery, and retry.



American Technologies Network Corp.

1341 San Mateo Avenue, South San Francisco, CA 94080
phone: 800-910-2862, 650-989-5100; fax: 650-875-0129

www.atncorp.com